

### BCS-SDHC4232-IV

PTZ camera 2Mpx HDCVI / AHD / TVI / ANALOG with 32 × zoom

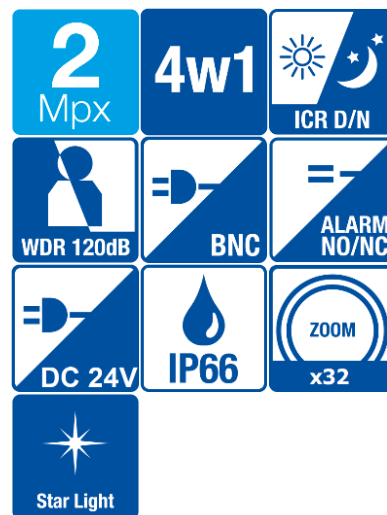

- 1 / 2.8 "2Mpx PS Starvis CMOS sensor
- Starlight technology
- Resolution 2Mpx (1920 × 1080) @ 30fps
- H.265 + / H.264 + / MJPEG compression
- 4.5 ~ 144mm lens 32 × optical zoom
- Mechanical infrared filter
- AWB, AES, AGC, BLC, HLC, WDR (120dB), Ultra DNR, Defog functions
- Infrared with a range of up to 150m
- 2 alarm inputs and 1 alarm output
- 1 audio input
- RS485 interface
- Max working speed 400 ° / s, PAN: 0 ° ~ 360 °, TILT: -15 ° ~ 90 °, auto flip
- Automation functions: 300 presets, 5 tracks, 8 tracks, auto-scan, auto-pan
- Intelligent 3D positioning
- IP66 external metal housing
- DC24V power supply

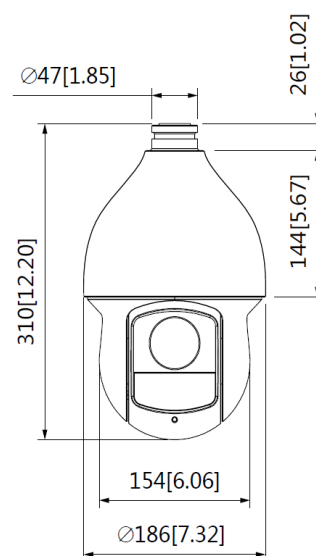

## BCS-SDHC4232-IV





PTZ camera 2Mpx HDCVI / AHD / TVI / ANALOG with 32 × zoom

Video system	HDCVI/AHD/TVI/ANALOG
Scanning system	Progressive Scan
Converter	1/2.8" 2Mpx Starvis CMOS
Resolution	1080P(1920×1080)@25/30fps, 720P(1280×720)@25/30/50/60fps
Compression	H.265+ / H.264+ / MJPEG
Video output	1 V p-p, composite, BNC, 75 Ohm
Tenderness	Color: 0.005Lux@F1.6; B/W: 0.0005Lux@F1.6; 0Lux@F1.6 (IR On)
Lens	Motozoom 4.5mm~144mm; F1.6~F4.0
Focus	Auto/manual
Iris	Auto/manual
Viewing angle	H: 60.14°~2.75°; V: 34.41°~1.54°; D: 68.23°~3.16°
Optical / digital zoom	32×/16×
DORI	Detect 1986m/ Observe 785m/ Recognize 398m/ Identify 198m
White balance	(AWB) Auto/manual
Background compensation	BLC/HLC/WDR(120dB)
Snapshot	1/3~1/100000s
Gain control	(AGC) Auto/manual
Noise reduction	Ultra 2D/3D DNR
Privacy mask	24 areas
Image rotation	Flip 180°
Day Night	IR cut filter with auto-switch IR (ICR)
IR range	Do 150m
Scope of the Polish	0°~360° endless
TILT range	-15°~90°, auto flip 180°
PAN speed	0.1°~300°/s (400°/s in preset)
TILT speed	0.1°~200°/s (300°/s in preset)
Automation functions	300 presets, 5 pattern, 8 tour, auto-scan, auto-pan
Startup / idle	Restore last PTZ position after power failure; activation of a preset, track, tour after a period of inactivity
Alarm	2 inputs / 1 output
Audio	1 input
Interfaces	RS485
Power	DC24V/2.5A(±25%), Power consumption 9.6W/22W (IR On)
Working conditions	-40°C ~+70°C / 10~95%RH
Dimensions and weight	310.0 mm × Φ186.0 mm 3.9kg



# BCS-SDHC4232-IV

PTZ camera 2Mpx HDCVI / AHD / TVI / ANALOG with 32 × zoom

<p>Wall mount+ adapter (included)</p>	
<p>Adapter BCS-ASDD</p>	
<p>Adapter BCS-ASD</p>	
<p>Corner mount BCS-AR</p>	
<p>Pole mount BCS-AS</p>	
<p>Adapter BCS-RD</p>	