

BCS-SDHC4225-IV

2Mpx HDCVI / AHD / TVI / ANALOG PTZ rotary camera with 25 × zoom

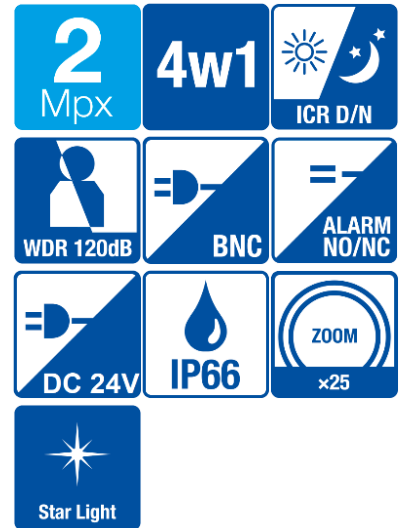

- 1 / 2.8 "2Mpx PS Starvis CMOS sensor
- Starlight technology
- 4.8 ~ 120mm 25 × optical zoom lens
- Mechanical infrared filter
- AWB, AES, AGC, BLC, HLC, WDR (120dB), Ultra DNR, Defog functions
- Max 2Mpx (1920 × 1080) @ 30fps
- Infrared heater with a range of up to 150m
- 2 alarm inputs and 1 alarm output
- 1 audio input
- Max working speed 400 ° / s, PAN: 0 ° ~ 360 °, TILT: -15 ° ~ 90 °, auto flip
- Automation functions: 300 presets, 5 tracks, 8 tracks, auto-scan, auto-pan
- Intelligent 3D positioning
- IP66 external metal housing
- DC24V power supply

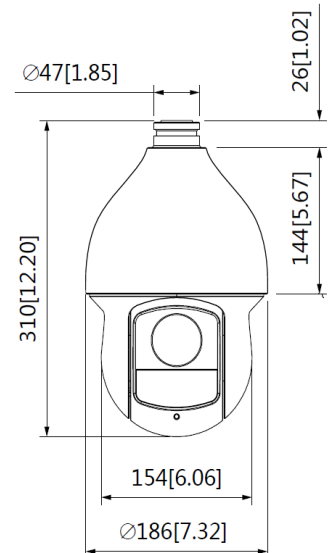

BCS-SDHC4225-IV





2Mpx HDCVI / AHD / TVI / ANALOG PTZ rotary camera with 25 × zoom

Video system	HDCVI/AHD/TVI/ANALOG
Scanning system	Progressive Scan
Sensor	1/2.8" 2Mpx Starvis CMOS
Resolution	1080P(1920×1080)@25/30fps, 720P(1280×720)@25/30/50/60fps
Video output	1 V p-p, composite, BNC, 75 Ohm
Min illumination	Color: 0.005Lux@F1.6; B/W: 0.0005Lux@F1.6; 0Lux@F1.6 (IR)
Lens	Motozoom 4.8mm~120mm; F1.6~F3.5
Viewing angle	H: 61°~2.8° V: 22.6°~0.4°
Optical / digital zoom	25×/16×
DORI	Detect 1655m/ Observe 657m/ Recognize 331m/ Identify 165m
White balance	(AWB) Auto/manual
Background compensation	BLC/HLC/WDR(120dB)
Shutter	1/3~1/100000s
Gain control	(AGC) Auto/manual
Noise reduction	Ultra 2D/3D DNR
Privacy mask	24 areas
Image rotation	Flip 180°
Focus	Auto/manual
Day Night	IR cut filter with auto-switch (ICR)
IR range	Do 150m
PAN range	0°~360° endless
TILT range	-15°~90°, auto flip 180°
PAN speed	0.1°~300°/s (400°/s preset)
TILT speed	0.1°~200°/s (300°/s preset)
Automation functions	300 preset, 5 tour, 8 pattern, auto-scan, auto-pan
Startup / idle	Restore last PTZ position after power failure; activation of a preset, track, tour after a period of inactivity
Alarm	2 input / 1 output
Audio	1 in
Interfaces	RS485
Power	DC24V/3A(±25%), Power consumption 9.6W/22W (IR)
Working conditions	-40°C ~+70°C / 10~95%RH
Dimensions and weight	310.0 mm × Φ186.0 mm 3.9kg



BCS-SDHC4225-IV

2Mpx HDCVI / AHD / TVI / ANALOG PTZ rotary camera with 25 × zoom

<p>Wall bracket + adapter (Included)</p>	
<p>Junction box BCS-ASDD</p>	
<p>Junction box BCS-ASD</p>	
<p>Corner mount BCS-AR</p>	
<p>Pole mount BCS-AS</p>	
<p>Pole BCS-RD</p>	